

POSITILT®

PTAM27

Universal MEMS Inclination Sensor with Analog Output



Analog Inclination Sensor with 1 axis or 2 axes in MEMS technology

- Measurement range $\pm 180^\circ$ with 1 axis or 2 axes
- Protection class IP67
- Linear analog output
- Plastic housing
- Wear free, high resolution
- High shock resistance

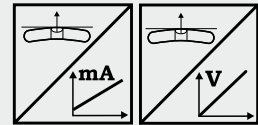

Specifications	Output /Excitation	U2	Voltage 0.5 ... 10 V / $U_B = 18 \dots 36$ V
			U6
		U8	Voltage 0.5 ... 4.5 V / $U_B = 10 \dots 36$ V
		I1	Current 4 ... 20 mA / $U_B = 18 \dots 36$ V, 10 ... 36 V
	Measurement range		$\pm 15 \dots \pm 180^\circ$ with 1 axis or 2 axes
	Resolution		0.1°
	Linearity		1 axis : $\pm 0.5^\circ$ ($\leq \pm 75^\circ$), $\pm 1^\circ$ ($> \pm 75^\circ$) 2 axes : $\pm 1^\circ$ ($\leq \pm 75^\circ$), $\pm 1.5^\circ$ ($> \pm 75^\circ$)
	Settling time		0.1 ... 10 s / 90 %, configurable
	Protection class		IP67
	Material		Plastic
	Connection		Cable 5 x 0.25 mm ²
	Shock (non-operational)		EN60068-2-27:1993, 100 g/11 ms, 100 shocks
	Vibration (non-operational)		EN60068-2-6:1995, 20 g/10 Hz-2 kHz, 10 cycles
	EMC, temperature		Refer to output specification

Order code PTAM27

PTAM27 - [] - [] - [] - [] - [] - []

Model name

Number of axes

- 1 = Inclination in X axis (mounting X)
- 2 = Inclination in X and Y axes (mounting XY)

Measurement range [in °]

- 15 ... 180 = $\pm 15^\circ \dots \pm 180^\circ$ in 15° increments

Output

- U2 = 0.5 ... 10 V
- U6 = 0.5 ... 4.5 V
- U8 = 0.5 ... 4.5 V
- I1 = 4 ... 20 mA

Characteristic

- CW = Increasing signal for CW inclination
- CCW = Increasing signal for CCW inclination

Output delay 0 ... 90 %

- Tx.x = 0.1 s ... 10 s

Connection

- KAB2M = Cable, standard length 2 m

Order example: PTAM27 - 1 - 90 - U6 - CCW - T1.0 - KAB2M

POSITILT®

PTDM27

Universal MEMS Inclination Sensor with CANopen Output



Digital Inclination Sensor with 1 axis or 2 axes in MEMS technology

- Measurement range $\pm 180^\circ$ with 1 axis or $\pm 60^\circ$ with 2 axes
- Protection class IP67
- CANopen output
- Plastic housing
- Wear free, high resolution
- High shock resistance

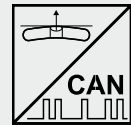

Specifications		
	Output	CANopen (profile „Inclination Sensor“)
	Measurement range	$\pm 180^\circ$ with 1 axis or $\pm 60^\circ$ with 2 axes
	Resolution	0.05 °
	Linearity	$\pm 0.5^\circ$
	Settling time	0.1 s ... 10 s / 90%, configurable
	Protection class	IP67
	Material	Plastic
	Connection	5 pin connector M12 with cable, fixed length 0.3 m
	Shock (non-operational)	EN60068-2-27:1993, 100 g/11 ms, 100 shocks
	Vibration (non-operational)	EN60068-2-6:1995, 20 g/10 Hz-2 kHz, 10 cycles
	EMC, temperature	Refer to output specification

Order code PTDM27

Model name

Output

CANOP = CANopen

CANJ1939 = CAN SAE J1939

Connection

KAB0.3M-M12/CAN = Cable (length 0.3 m) with connector M12, 5 pin

PTDM27

Order code connector cable (see page 9)

KAB - XM - M12/5F/G - M12/5M/G - CAN

Order example: PTDM27 - CANOP - KAB0,3M-M12/CAN

POSITILT®
PTAM27/PTDM27
Dimensions



Outline drawing
PTAM27/PTDM27

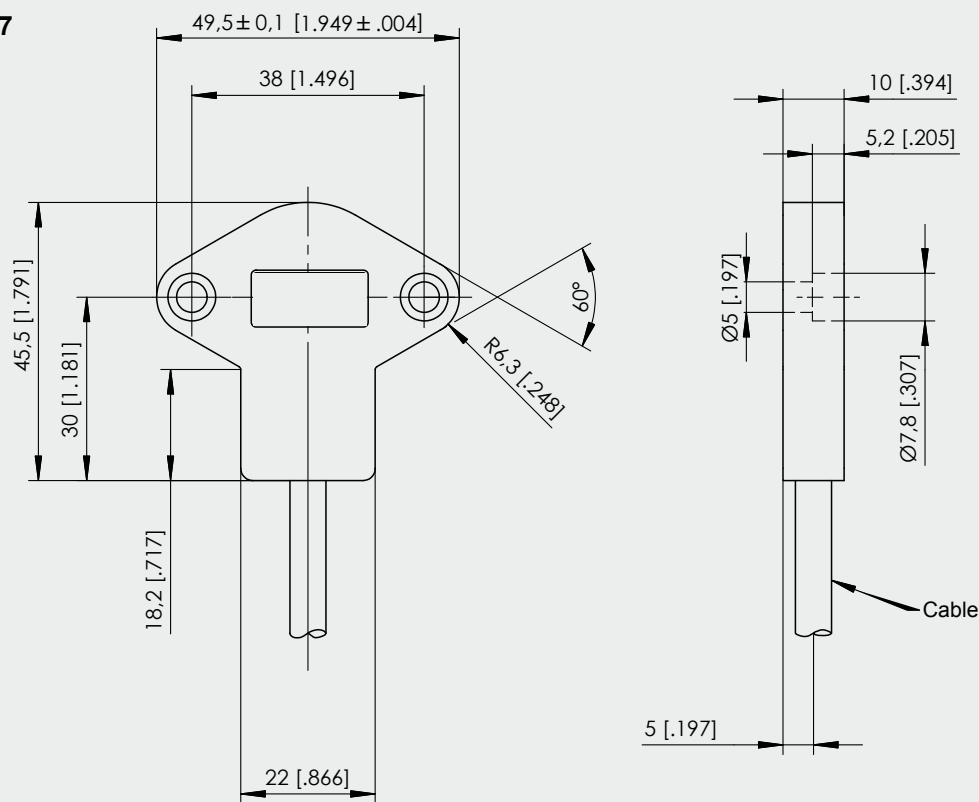

Dimensions in mm [inch]

Dimensions informative only.
For guaranteed dimensions consult factory.

POSITILT®
PTAM27/PTDM27
Dimensions



**Orientation of the
inclination axes**

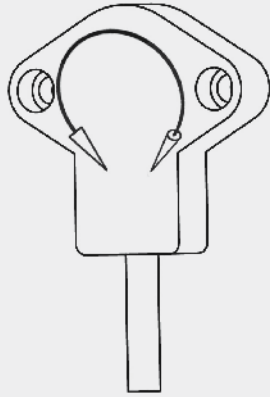

1 axis

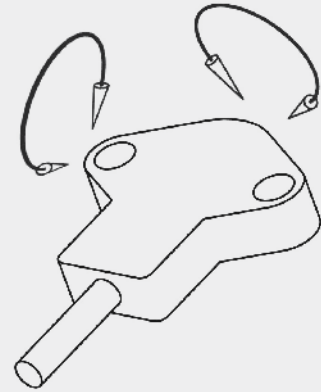

2 axes

<p>U2 Voltage Output 0.5 ... 10 V</p>	Excitation voltage	18 ... 36 V DC
	Excitation current	12 mA typ., 16 mA max.
	Output voltage	0.5 ... 10 V DC
	Output current	2 mA max.
	Measuring rate	1 kHz standard
	Stability (temperature)	$\pm 100 \times 10^{-6} / ^\circ\text{C}$ f.s. (typ.)
	Operating temperature	-40 ... +85 °C
	Protection EMC	Reverse polarity, short circuit EN61326-1:2006
<p>U6 Voltage Output 0.5 ... 4.5 V DC</p>	Excitation voltage	5V DC $\pm 10\%$
	Excitation current	16 mA typ., 20 mA max.
	Output voltage	0.5 ... 4.5 V DC
	Output current	2 mA max.
	Measuring rate	1 kHz standard
	Stability (temperature)	$\pm 100 \times 10^{-6} / ^\circ\text{C}$ f.s. (typ.)
	Operating temperature	-40 ... +85 °C
	Protection EMC	Reverse polarity, short circuit EN61326-1:2006
<p>U8 Voltage output 0.5 ... 4.5 V</p>	Excitation voltage	10 ... 36 V DC
	Excitation current	12 mA typ., 16 mA max.
	Output voltage	0.5 ... 4.5 V DC
	Output current	2 mA max.
	Measuring rate	1 kHz standard
	Stability (temperature)	$\pm 100 \times 10^{-6} / ^\circ\text{C}$ f.s. (typ.)
	Operating temperature	-40 ... +85 °C
	Protection EMC	Reverse polarity, short circuit EN61326-1:2006
<p>I1 Current Output 4 ... 20 mA</p>	Excitation voltage	18 ... 36 V DC; 10 ... 36 V for R<250Ω
	Excitation current	32 mA typ., 36 mA max..
	Load resistor	500 Ω max.
	Output current	4 ... 20 mA
	Measuring rate	1 kHz standard
	Stability (temperature)	$\pm 100 \times 10^{-6} / ^\circ\text{C}$ f.s. (typ.)
	Operating temperature	-40 ... +85 °C
	Protection EMC	Reverse polarity, short circuit EN61326-1:2006

Other outputs available on request.

Output signals

Connection

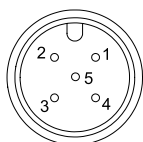

M12A5 / M12R5

View to sensor connector



Signal Wiring	Output signals		Connector pin	Cable color
	1 axis	2 axes		
	Excitation +	Excitation +	1	brown
	Output X	Output X	2	white
	GND	GND	3	blue
	Do not connect!	Output Y	4	black
	Do not connect!	Do not connect!	5	gray

POSITILT[®] PTDM Output CANopen



Description Inclination sensor with CANopen interface according to CiA 410.

CANopen Interface 	Communication profile	CANopen CiA 301 V 4.02, Slave
	Device profile	Encoder CiA 410 V 1.2
	Configuration services	LSS, CiA Draft Standard 305 (transmission rate, node ID)
	Error Control	Node Guarding, Heartbeat, Emergency Message
	Node ID	Adjustable via LSS or via object dictionary, default: 127
	PDO	1 TxPDO, 0 RxPDO, static mapping
	PDO Modes	Event-/Time triggered, Remote-request, Sync cyclic/acyclic
	SDO	1 Server, 0 Client
	Certified	Yes
	Transmission rate	50 kBaud to 1 MBaud, adjustable via LSS or via object dictionary, default: 125 kBaud
	Bus connection	M12 connector, 5 pin
	Integrated bus terminating resistor	Optional
	Bus, galvanic isolation	No

Specifications	Excitation voltage	8 ... 36 V DC
	Excitation current	15/30 mA typical for 24/12 V, 100 mA max.
	Measuring rate	1 kHz standard
	Stability (temperature)	$\pm 100 \times 10^{-6} / ^\circ\text{C}$ f.s.
	Repeatability	1 LSB
	Operating temperature	-40 ... +85 °C
	Protection	Reverse polarity, short circuit
	EMC	EN61326-1:2006

POSITILT[®]
PTDM
Output CAN SAE J1939



Description Inclination sensor according to standard SAE J1939. Configuration of operating parameters by proprietary-A-Message (peer-to-peer connection). Process data exchange by proprietary-B-Message (broadcast).

Interface J1939 	CAN specification	ISO 11898, Basic and Full CAN 2.0 B
	Transceiver	24V-compliant, not isolated
	Communication profile	SAE J1939
	Baud rate	250 kbit/s
	Internal termination resistor	120 Ω
	Address	Default 247d, configurable

NAME Fields	Arbitrary address capable	1	Yes
	Industry group	0	Global
	Vehicle system	7Fh (127d)	Non specific
	Vehicle system instance	0	
	Function	FFh (255d)	Non specific
	Function instance	0	
	ECU instance	0	
	Manufacturer	145h (325d)	Manufacturer ID
	Identity number	0nnn	Serial number 21 bit

Parameter Group Numbers (PGN)	Configuration data	PGN EF00h	Proprietary-A (PDU1 peer-to-peer)
	Process data	PGN FFnnh	Proprietary-B (PDU2 broadcast); nn Group Extension (PS) configurable

Specifications	Excitation voltage	8 ... 36 V DC
	Excitation current	15/30 mA typical for 24/12 V, 100 mA max.
	Measuring rate	1 kHz standard
	Stability (temperature)	±100 x 10 ⁻⁶ / °C f.s.
	Repeatability	1 LSB
	Operating temperature	-40 ... +85 °C
	Protection	Reverse polarity, short circuit
	EMC	EN61326-1:2006

Signal wiring / connection	Signal name	Connector pin
	Shield	1
	Excitation +	2
	GND	3
	CAN-H	4
	CAN-L	5

View to sensor connector

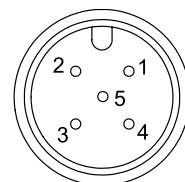

POSITILT[®]
PTAM/PTDM
Characteristic of the linear output



Output signal

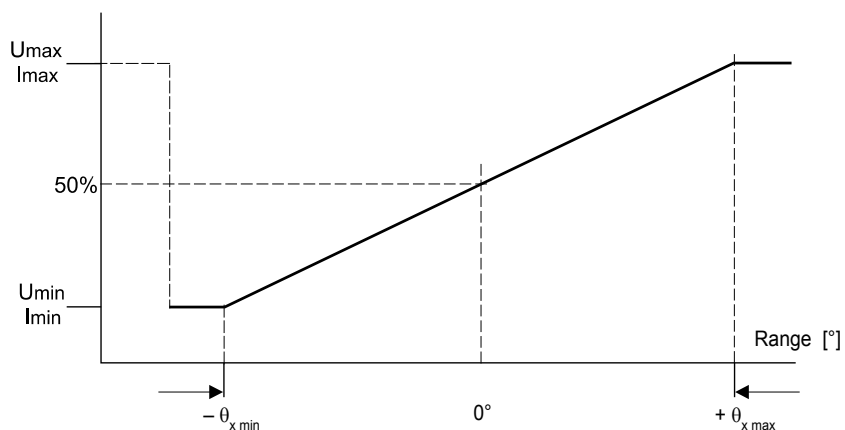

PTAM27/PTDM27

1 axis

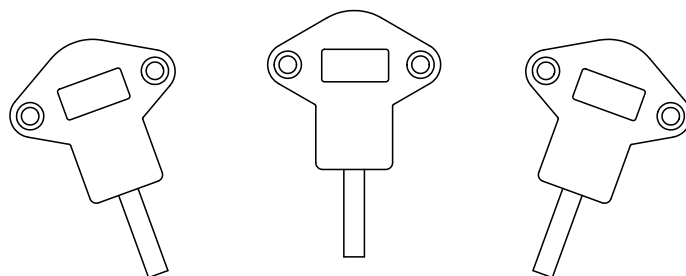

PTAM27/PTDM27

2 axes

X

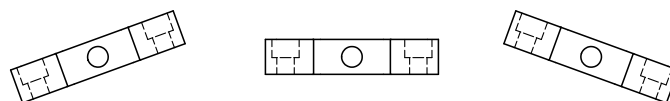

Y

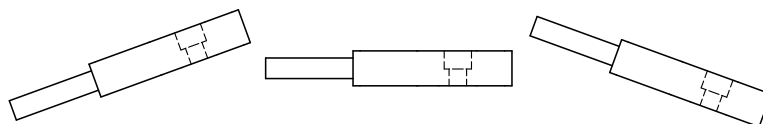

POSIROT® / POSITILT®

Accessories Connector Cables



**Connector/bus cable
for POSIROT®-
POSITILT® sensors**
5 pin M12
CAN bus

The 5-lead shielded cable is supplied with a female 5-pin M12 connector at one end and a male 5-pin M12 connector at the other end. Available lengths are 2, 5 and 10 m.

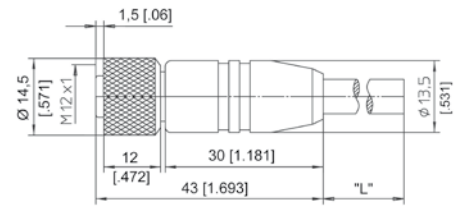

Order code:

KAB - XM - M12/5F/G - M12/5M/G - CAN

IP69K: KAB - XM - M12/5F/G/69K - M12/5M/G/69K - CAN

Length in m

T-piece for bus cable
5 pin M12
CAN bus

Order code:

KAB - TCONN - M12/5M - 2M12/5F - CAN



**Terminating
resistance**
5 pin M12
CAN bus

Order code:

KAB - RTERM - M12/5M/G - CAN

